









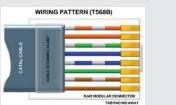

Do's and Don'ts - Tips for Success

Here are some best practices to follow and some of the most common mistakes to avoid. Keeping these tips in mind will assure you have a successful install.

DO use cable hangers.	
DO run your CAT-5e cable at a 90° angle across power lines when crossing cables is necessary. DO NOT run CAT-5e parallel to or in close proximity to high voltage cables or sources of interference. DO leave at least 12" clearance from sources of line voltage.	
DO terminate cables according to T568B. DO make sure crimps are deep, straight and that the blades penetrate the conductors evenly for proper contact.	
DO use a remote cable tester to verify each CAT-5e cable.	
DO NOT use cables with strain-relief boots at connectors. Some nLight devices have limited cabling space that does not allow for boots.	
DO protect CAT-5e connectors (bag and tie) and cover open ports if construction is ongoing and connections cannot be completed. DO NOT use tape on connectors - residue from tape will cause poor connections.	
DO NOT leave excess cable coiled up. Cut cable to appropriate length. DO leave a short service loop at the end of each cable run.	
DO NOT damage the jacket or overstress the conductors.	
DO NOT exceed 1500 feet CAT-5e per nLight Control Zone.	
DO check the nLight device RJ45 port for debris or bent pins before inserting connector. DO seat the connector carefully and fully into the RJ45 jack, observing which side has the clasp vs. pins. Insert until locking hinge clicks to secure connector in port.	

Need help? Contact Tech Support at **800-535-2465**.



Pocket Guide



This pocket guide will help you quickly and easily get your nLight® devices connected and operating.

The guide includes:

- Basic terminology
- Expected, out-of-the-box functionality
- Bus power budget considerations
- Connecting devices to create an nLight Control Zone
- How to inter-connect multiple Control Zones using nLight Backbone devices
- Troubleshooting tips
- Installation Do's and Don'ts

The guide assumes:

1. A basic familiarity with nLight products and concepts
2. Familiarity with CAT-5e cabling and terminations
3. nLight devices are installed and wired to line voltage per device datasheets

Terminology

Understanding these terms will help you make the most of this guide.

nLight device - An intelligent digital device having the ability to communicate over an nLight network. Device types include occupancy sensors, photocells, power/relay packs, wall switches, dimmers and panels.

Blink Codes - nLight devices show status and diagnostic codes by blinking their LED(s) in defined patterns.

CAT-5e - network cable to connect nLight devices. The T568B wiring standard is required for the order of conductors in the cable termination (RJ45 plug).

RJ45 - Physical standard describing the mating connectors used on CAT-5e cabling in both nLight bus networks and IEEE 802.3 Ethernet networks.

Bus - the CAT-5e cable connecting the devices in an nLight Control Zone. The bus enables communications between devices using the TIA-485 Standard and carries low-voltage DC operating power for the devices.

Lighting Zone - A group of lights wired or configured to operate together.

Control Zone - A collection of nLight devices and/or nLight enabled luminaires that function together in order to control a space's lighting. Typically, one control zone per room is used, however large areas (such as open offices) may require multiple zones. Zones can also be subdivided via configuration to cover several small rooms.

Out of the Box - It Just Works

nLight devices ship with default settings so that they simply work, right out of the box. With as little as a switch or sensor and a Power Pack wired to lights, you can create a perfectly functional nLight Control Zone.

Consider a simple office with an nPODM wall switch and a Power Pack wired to the room's light fixture. The nPODM broadcasts switch status (ON/OFF) on Channel 1, and the Power Pack tracks (obeys) switch status changes on Channel 1. Right out of the box, the nPODM can control the room's lighting.

This table shows default Broadcast (status) channels for a sampling of nLight WallPod switches, and default Tracking (listening) channels for common Power Pack devices; devices with 2P or 4P indicate multiple poles.

		Switch Channels			
	Device	1	2	3	4
Broadcast	nPODM	x			
	nPODM 2P	x	x		
	nPODM 4P	x	x	x	x
Tracking	nPP16 D	x			
	nPP16 D SW2		x		
	nSP5 PCD	x			
	ARP INTENC08 NLT	x			

Occupancy Channel (default) - All sensors broadcast on Channel 1.
All devices tracking, track Occupancy Channel 1.

Photocell Channel (default) - All sensors broadcast on Channel 1.
All devices tracking, track Photocell Channel 1.

Defaults	Broadcast	Track
Occupancy	Channel 1	Channel 1
Photocell	Channel 1	Channel 1

Backbone - The communication network formed by nLight Bridges and nLight ECLYPSE® devices that is required to deploy remote or time-based changes, such as a scheduled override, out to a device, groups of devices, or zone(s). Additionally, advanced features, such as performance monitoring and interfacing with higher level BMS systems, require the end-to-end network connectivity that the backbone provides.

Bridge (nBRG 8) - nLight backbone device with 8 RJ45 ports to connect control zones, other Bridges, or an nLight ECLYPSE. Bridges act as hubs by aggregating communication traffic from connected zones onto the backbone. Bridges also act as routers by forwarding information from the backbone out to the applicable zones. Additionally, Bridges combine system power from zones that are net contributors of power and distribute it to zones that are net consumers of power.

nLight ECLYPSE® - An nLight backbone device that maintains a database of all downstream nLight devices, provides time clock functionality, stores custom operating profiles, and displays system status. This device links an nLight backbone to the host computer of the SensorView™ Management software via an Ethernet LAN/WAN network. This device also hosts on-board edge applications that provide system information (e.g. nLight Explorer) and is a BACnet native device (BTL listed BACnet Building Controller). It supports connection to a touch screen display (nGWY2 GFX), and is optionally sold within an enclosure and powered by a 24V power supply (PS50X).

WallPod® (or nPODM) - general term for an nLight wall station. WallPods are available in many configurations that enable occupants to issue On, Off, Raise, Lower, and/or Scene selection commands. WallPods have model numbers that start with nPOD(M).

nLight Power Considerations

Each nLight zone supports up to 128 devices. Some devices provide power, others consume it. Most nLight devices use only 3-4 mA, some up to ~8mA; nLight power generating devices typically provide 30-40 mA per RJ45 port.

For nLight zones with more than 6 devices, you should carefully budget power consumption to ensure that all devices have adequate power. Device data sheets give accurate power generation or consumption values.

Tips to avoid Low Voltage in a Control Zone

- Remember that nLight device placement is flexible. Locate Power Packs mid-Zone. Ex: in an 11-device Control Zone, place Power Pack as device #6. Each side of the Power Pack offers 40mA, or 8mA per device. If the Power Pack were device #1 or #11, less power is available per device.
- Calculate the power load and make sure there are enough power-supplying devices placed appropriately in the Control Zone.
- A Bridge can redistribute power from Zones with a surplus to Zones with a deficit. When coupled with a PS150 supply, a Bridge has ~90mA available to share with connected Zones that need power.

The illustration below shows how a Bridge can share power with Control Zones that need it, as well as re-distribute power from Zones with excess power.

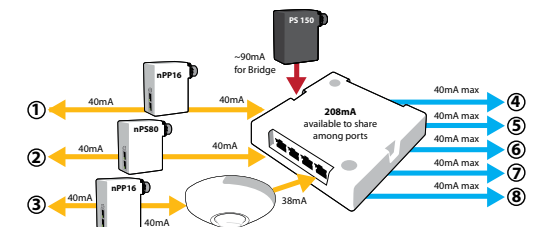

Installing a Control Zone

nLight devices in zones can be wired together in any order, using CAT-5e cables. Daisy-chain (linear) topology is required. Any factory T-tap devices have been confirmed by the factory. Control zones can have a maximum of 128 nLight devices wired together in any order on a single bus of CAT-5e cables. The maximum cable

length for a zone is 1500 feet. Typically, one or more of the devices in a zone will supply sufficient bus power for all devices in the zone (see bus power section on reverse) to power up and begin default operation without any additional configuration.

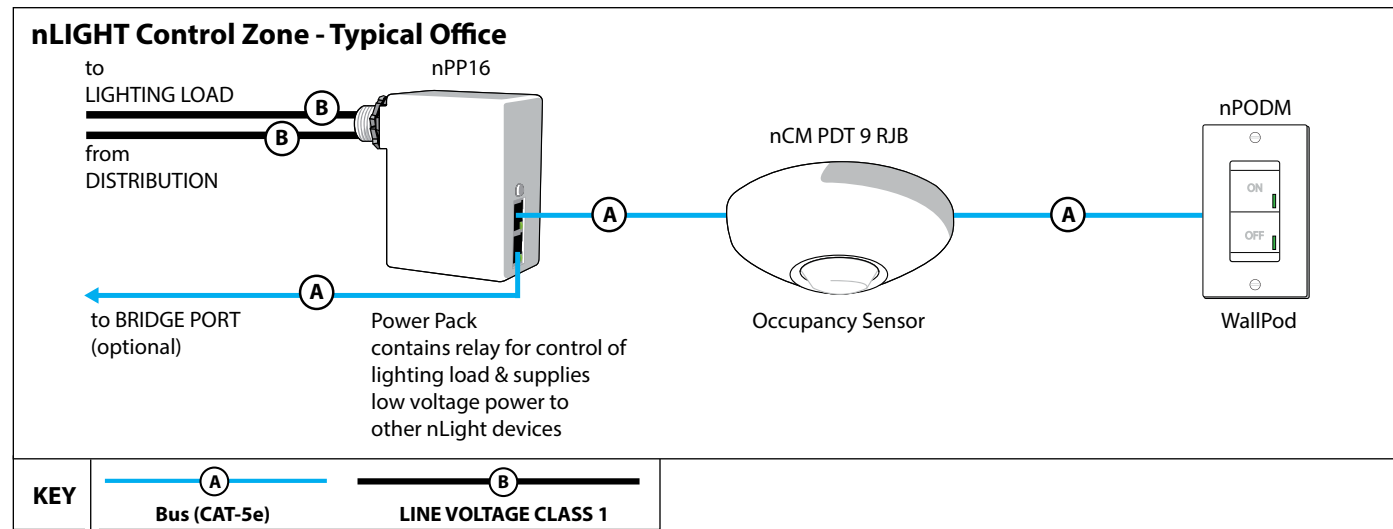

CAT5e Wiring Steps (Note: Assuming all line voltage/dimming wiring completed)

1. Locate one of the devices that provides power to the bus, and run CAT-5e cable to the next nLight device in the daisy chain. Install connectors as necessary, terminating cables according to T568B. Review the tips in the *Do's and Don'ts* section to ensure install goes smoothly.
2. If the device location has not previously been recorded, do so during installation. It is very helpful information to have later on. There are two Serial ID# stickers on every nLight device; use the second sticker to record the device location. Adjacent to the sticker, record the device type (i.e., LED fixture or ceiling sensor) and location (i.e., Room 216 Row 2 ceiling)
3. Plug the CAT-5e cable into the power-supplying device. It does not matter which of the RJ45 ports you plug into on a device with two ports.
4. Plug the other end of the CAT-5e cable into an available RJ45 port at the next device.
5. As soon as the device is plugged in and has bus power, the LED should display a rapid flash followed by two blinks as the device boots up. If you don't see LEDs come on, re-check the cable, using the tips from the *Do's and Don'ts* table.
6. As each device is added, you'll see LED activity during network discovery, after which the LEDs will settle into default states. Power Pack and switch (WallPod) LEDs will be either solid on or off; occupancy sensor LEDs light up according to what they observe. If the LEDs on a device are instead blinking in a pattern, see the *Device Blink Codes* table, at right.

Troubleshooting the Zone - Device Blink Codes

All nLight devices are equipped with status LEDs. These LEDs are used in conjunction with the device's push button for programming and configuration, but the rest of the time they indicate status and display any error code that may be present at the device. The table at the right tells how to interpret common error codes from the LED blinks.

Blink Pattern	Meaning
Device has two LEDs, and the left LED is on solid (not blinking)	Device is Polling on the nLight network, this is expected operation.
Constant rapid flash of all LEDs	A device firmware update is in process. Wait for the update to complete. (Note: If on a photocell device, transition mode)
Rapid flash for 1 second, followed by two blinks	No TIA-485 communications between devices. Check CAT-5e cable connections, pins, etc.
Rapid flash for 1 second, followed by three blinks	Low voltage on the port; this indicates a lack of bus power. Add a bus-powering device to supply additional voltage. See nLight Power Considerations for more info.
Rapid flash for 1 second, followed by four blinks	This indicates a device's firmware is incompatible with the other devices in this zone. Newer firmware devices will display this blink pattern. Remove the device and replace it with an up-to-date unit, or use SensorView Software to update the device's firmware to a compatible version.

Installing a Backbone

An nLight backbone consists of devices called "Bridges" and "nLight ECLYPSES" connected with CAT-5e cables. Individual control zones are each cabled to a port on a Bridge, which may also be cabled to other Bridges or directly to a single

nLight ECLYPSE. One or more nLight ECLYPSE devices are then typically linked together over an Ethernet LAN/WAN (not provided) to a host computer or server (supplied by customer) running the SensorView™ management software.

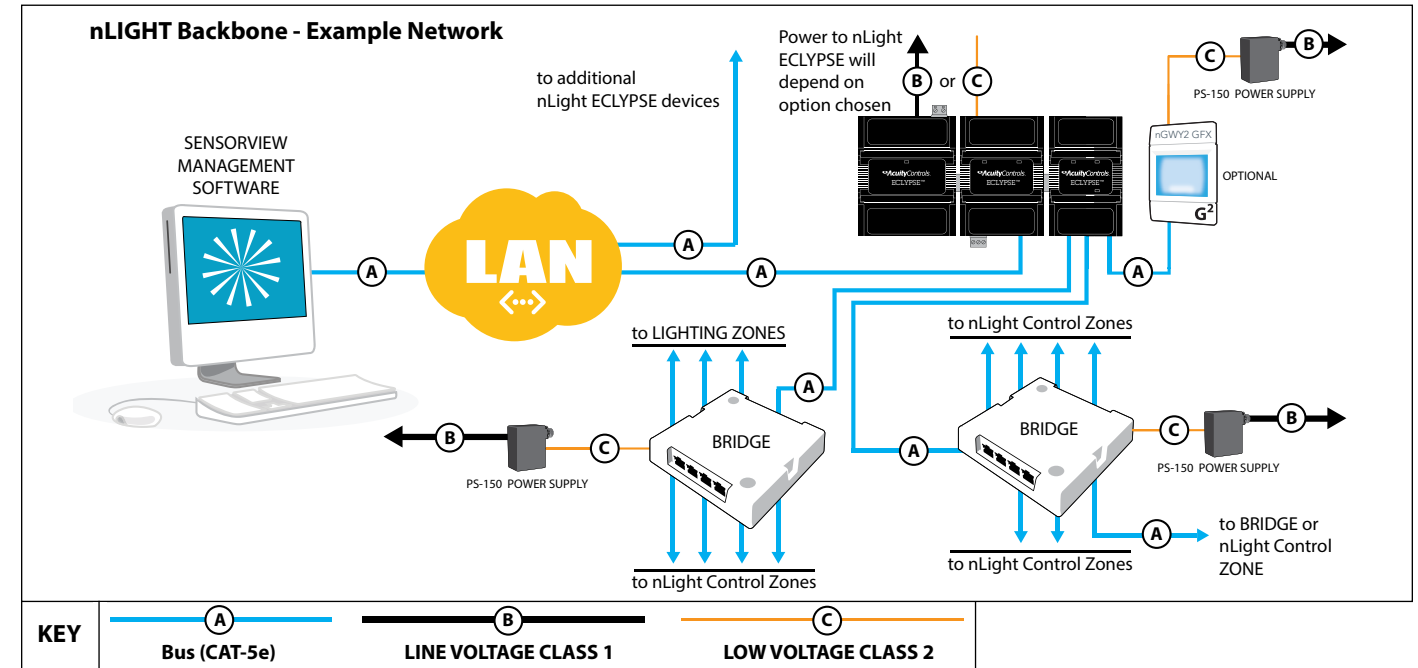

Writing Steps

1. Start by installing the nLight ECLYPSE. Confirm that the controller and optional display (nGWY2 GFX) are powered, and the display is cabled to the port marked "GFX" on the controller. A beating green heart symbol on the display indicates communication is present between the two devices. (Note: no other devices besides the nLight ECLYPSE should be cabled to the rear of the nGWY2 GFX device)
2. The device count should register one on the display. (Note: Display is optional. nLight Explorer is an application pre-loaded to each controller that can also be used - see "nLight Explorer User Guide" for more information.)
3. Plug in the first Bridge to the Port 1 on the controller. The display will show the device count increment by one.
4. Plug in one nLight zone at a time to the Bridge. Check that the controller's device count increments by the number of devices added in each zone. If it is not already recorded, write down the Bridge location, Control Zone name, and the Bridge port number used. (Note: If it is not convenient to get the device count from the nLight ECLYPSE controller, see "Checking Device Count from Bridge", at right)
5. Repeat Step 4 until all zones are connected to the first Bridge. (Note: additional Bridges may be connected to Bridge ports. For example, a Bridge may be cabled to 5 downstream control zones, 2 downstream Bridges, and the upstream nLight ECLYPSE.)
6. Repeat Steps 3 - 5 using Port 2 on the nLight ECLYPSE if necessary.

Troubleshooting the Zone - Device Blink Codes

You can see the status of an individual Zone as it is connected to the Bridge by observing the LED for that Bridge Port, and interpreting its Blink Pattern when in port status mode.

Port Status Blink Pattern	Meaning
1 Blink	Zone is healthy.
2 Blinks	Upstream Bridge or Gateway is detected.
3 Blinks	nCOMKIT Connected to Port/Zone.
4 Blinks	Downstream Bridge is detected.
5 Blinks	Too many Adds/Deletes on the port. Reset the Bridge.
6 Blinks	Two Bridge ports are cabled together, creating a Bridge Loop. Check Bridge wiring and remove the loop.

You should also observe the device count at the nLight ECLYPSE, and check that the count increments correctly as each Control Zone is cabled to its Bridge port.

Checking Device Count from Bridge

The Bridge has a push-button and one indicator LED per port. Pressing the push-button causes the LEDs to toggle between port status mode and device count mode. In device count mode, each port LED (one after another) reports the number of detected devices by blinking out a two digit number - 1st DIGIT (pause) 2nd DIGIT. Rapid blinking indicates the number zero. If the count is greater than 99, three digits will be blinked in a similar manner. A port LED that does not blink, or blinks erratically, indicates a broken or miswired CAT-5e connection.